

SWITCHES

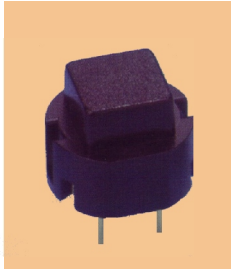

D6 Quadrada

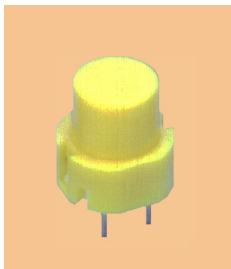
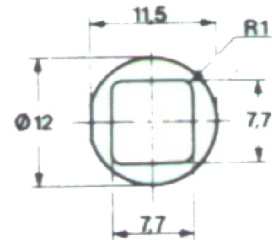
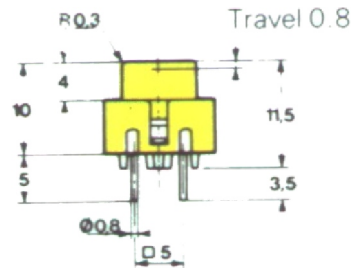

D6 Redonda

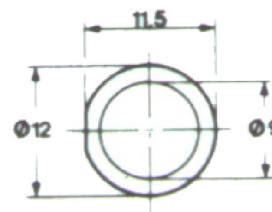
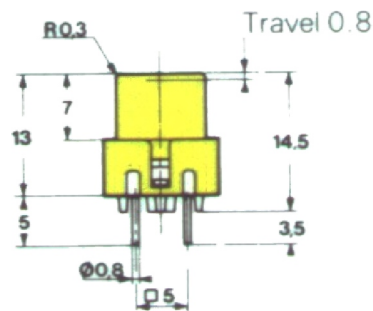

D6 S/haste

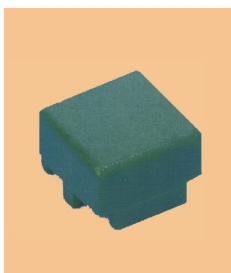
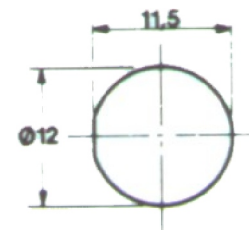
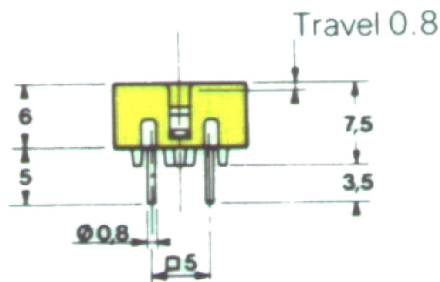

Capa D6

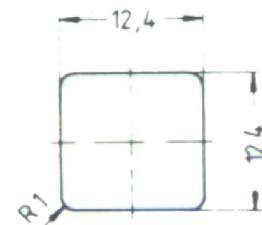
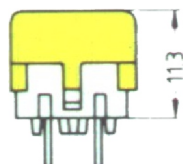

Operation Force Color	LIFE CYCLE	Rating (max.)	Contact Resistance
Light Grey Black	250.000	10mA 35V DC	30 mΩ max.